

Technische Fiche



Zurich

## BESCHRIJVING

Het model Zurich levert perfect zitcomfort in een zetel met sobere, strakke lijnen. Dit model heeft een robuuste, toch gezellige uitstraling, die past in verschillende interieurstijlen. De zetel kan gemaakt worden naar opstelling en maat van uw interieur. De enorme keuze aan leders en stoffen waarin dit model uitgevoerd kan worden kunnen de perfecte aansluiting maken bij uw interieur. Het is een heerlijk comfortabel model dankzij verschillende beschikbare zitdieptes en hoogtes. Het model is verkrijgbaar in canapé, hoek en chaise longue. Al deze elementen zijn individueel aanpasbaar en combineerbaar, zo stelt u zelf de ideale zetelcombinatie samen voor uw interieur.



**STAP 1**  
Kies uw model



**STAP 2**  
Bepaal uw exacte  
maatvoering



**STAP 3**  
Kies uw zitcomfort



**STAP 4**  
Kies uw stof of leder

## ZETELS

Voorbeeld

Fauteuil

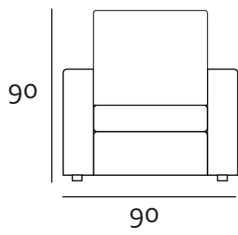

2-zit

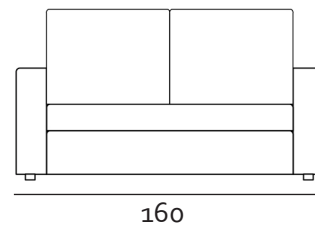

2,5-zit



3-zit

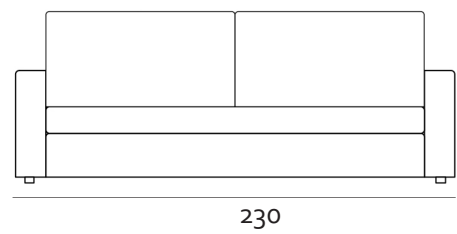

Zijaanzicht

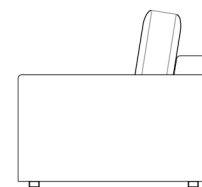
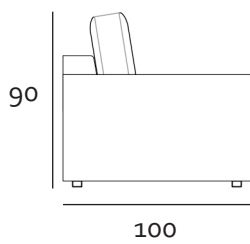

## LONGCHAIR

Voorbeeld

Breedte small

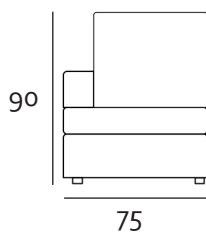

Breedte medium

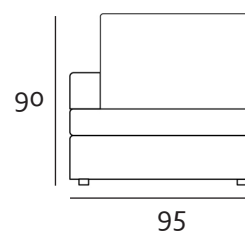

Zijaanzicht

Lengte medium

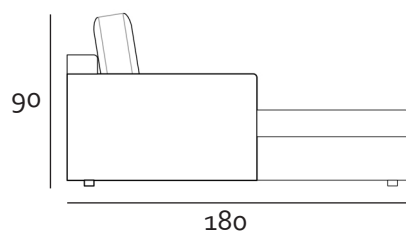

Lengte large

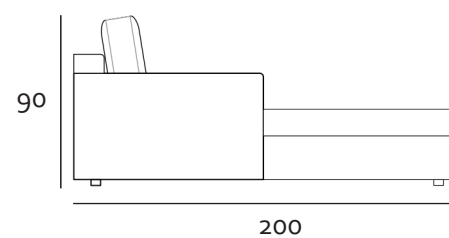

Alle onderdelen zijn op maat aanpasbaar



## HOEKELEMENT

Vooraanzicht

Gesloten

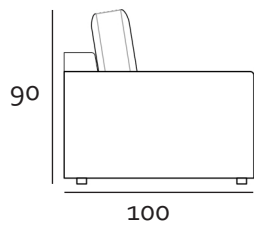

Open

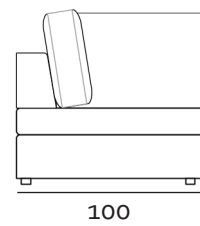

Zijaanzicht

3-zit gesloten

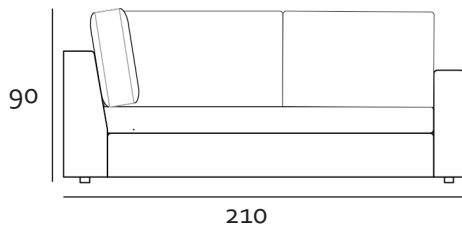

3-zit open

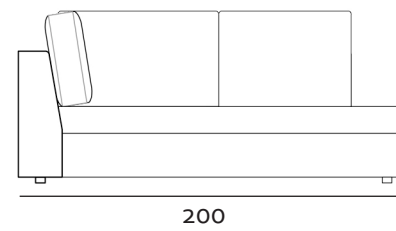

4-zit open



## AANSLUITELEMENT

Vooraanzicht

2-zit leuning

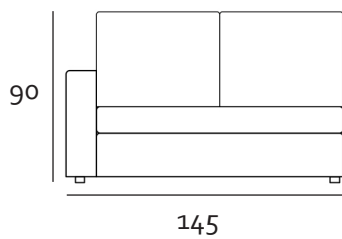

3-zit leuning

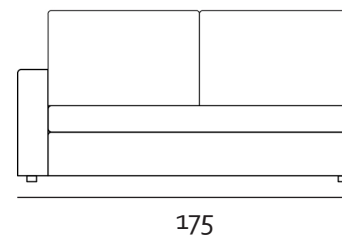

3,5-zit leuning

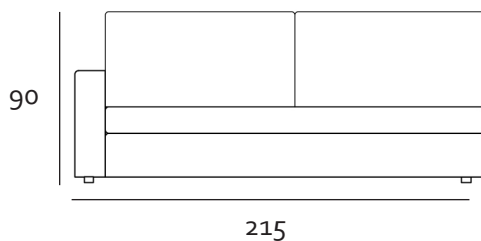

4-zit leuning

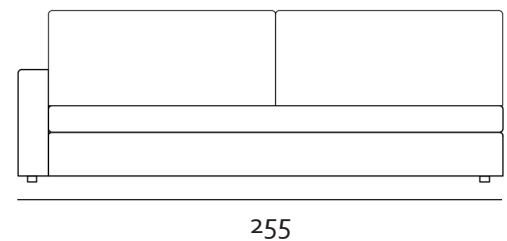

Zijaanzicht

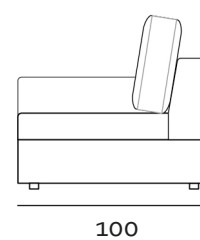
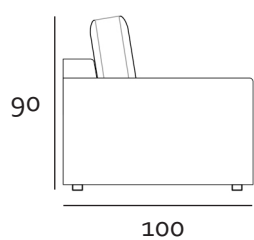

Alle onderdelen zijn op maat aanpasbaar  
De arm- en rugleuning kunnen zowel links als recht worden gemaakt



## POEF

Small

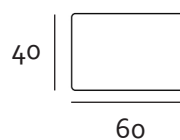
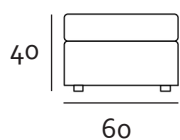

Medium

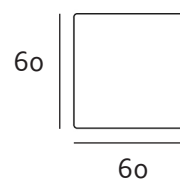
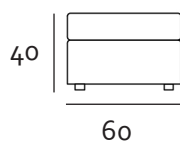

Large

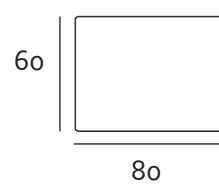
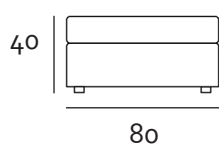

## VOORBEELD OPSTELLING

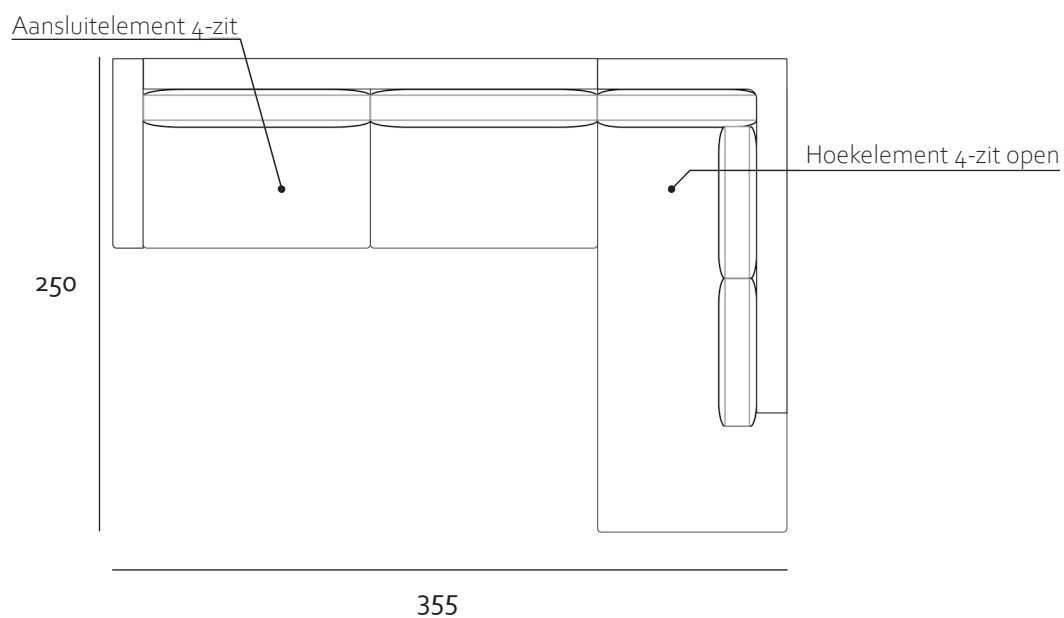



+32(0)15 26 06 06

[www.cammers.be](http://www.cammers.be)

Winketkaai 7, 2800 Mechelen